

Series 22

Proven. Durable and powerful.

<https://eao.com/>



22 Information about the Series

Key advantages

- Reliable switching of high loads
- Compact construction
- Long travel tactile action

Typical application areas

- Building services and automation
- Control cabinets
- Rail, electrical and waterbound vehicles

Functions

- Illuminated pushbutton
- Mushroom-head pushbutton
- Selector switch
- Indicator

Design

- Flush

IP front protection

- IP65

Raitings

- 400 VAC (10 A)

Mounting cut-outs

- 22 mm x 30 mm

Terminal

- Plug-in terminal
- Screw terminal

Lens Material

- Plastic

Markings

- Engraving
- Hot stamping
- Film insert/markings plate

Approvals

- CB (IEC 61058)
- CSA
- ENEC (EN 61058)
- UL

Conformities

- CE
- UKCA
- 2014/35/EU (LVD)
- 2011/65/EU (RoHS)



Flush design		
Illuminated pushbutton	430	01
Mushroom-head pushbutton	432	02
Keylock switch 2 positions	434	
Indicator	435	
Components	436	03
Accessories	439	
Technical data	442	04
Marking	443	
Application guidelines	445	09

- 14
- 17
- 18
- 19
- 22**
- 31
- 41
- 45
- 51
- 56
- 57
- 61
- 70
- 71
- 82
- 84
- 92
- 96

22 Flush design

Illuminated pushbutton, IP65



Product can differ from the current configuration.

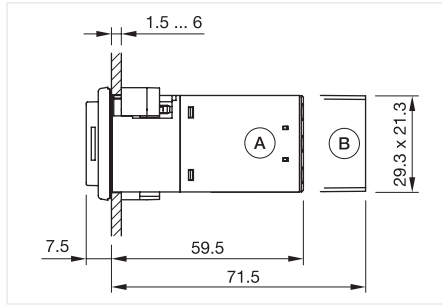

Dimensions [mm]
 A = Screw terminal
 B = Plug-in terminal 6.3 mm x 0.8 mm

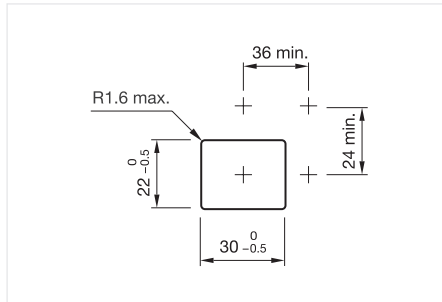

Mounting cut-outs [mm]

Equipment consisting of (schematic overview)



Lens

Page 436



Front bezel

Page 436



LED

Page 437

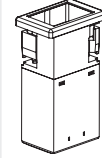

Actuator

Each Part Number listed below includes all the black components shown in the 3D-drawing.

To obtain a complete unit, please select the red components from the pages shown.



Actuator, Front dimension 36 mm x 24 mm

Switching action	Contacts	Terminal	Part No.	Wiring diagram
Momentary	1 NO	Screw terminal	22-211.011	152
	1 NO	Plug-in terminal	22-211.014	152
	1 NC	Screw terminal	22-212.011	148
	2 NO	Screw terminal	22-213.011	155
	2 NO	Plug-in terminal	22-213.014	155
	2 NC	Screw terminal	22-214.011	154
	1 NC / 1 NO	Screw terminal	22-215.011	150
	1 NC / 1 NO	Plug-in terminal	22-215.014	150
Maintained	1 NO	Screw terminal	22-221.011	153
	1 NO	Plug-in terminal	22-221.014	153
	1 NC	Screw terminal	22-222.011	149
	2 NO	Screw terminal	22-223.011	156
	2 NO	Plug-in terminal	22-223.014	156
	1 NC / 1 NO	Screw terminal	22-225.011	151
	1 NC / 1 NO	Plug-in terminal	22-225.014	151

Contacts: NC = Normally closed, NO = Normally open

Wiring diagrams

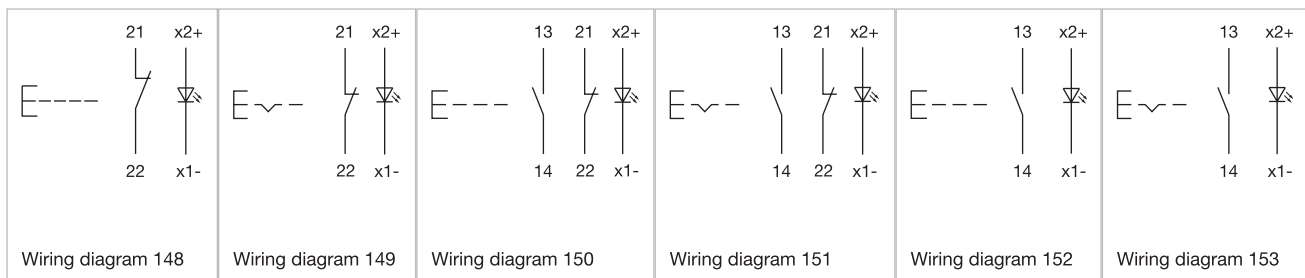

Wiring diagrams

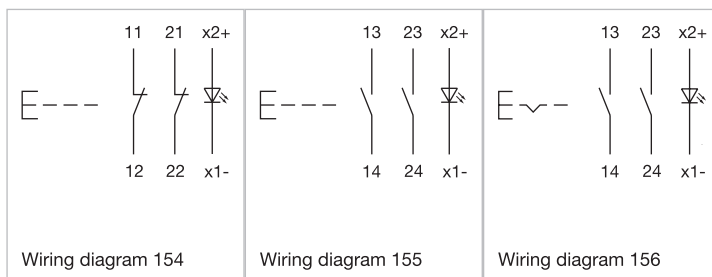

- 01
- 02
- 03
- 04
- 09
- 14
- 17
- 18
- 19
- 22**
- 31
- 41
- 45
- 51
- 56
- 57
- 61
- 70
- 71
- 82
- 84
- 92
- 96

22 Flush design

Mushroom-head pushbutton, IP65

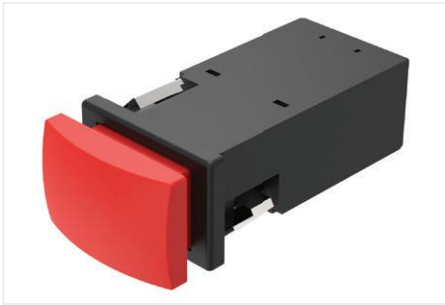

Product can differ from the current configuration.

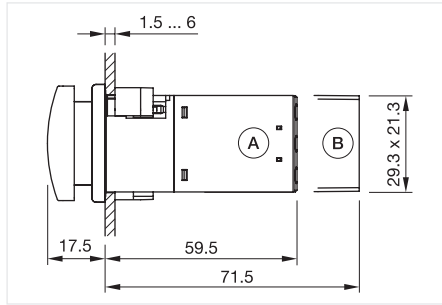

Dimensions [mm]
 A = Screw terminal
 B = Plug-in terminal 6.3 mm x 0.8 mm

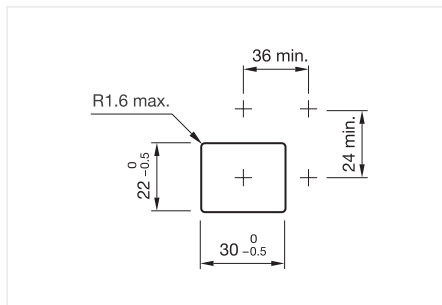

Mounting cut-outs [mm]

Equipment consisting of (schematic overview)



Lens

Page 436

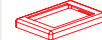

Front bezel

Page 436

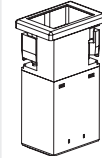

Actuator

Each Part Number listed below includes all the black components shown in the 3D-drawing.

To obtain a complete unit, please select the red components from the pages shown.



Actuator, Front dimension 36 mm x 24 mm

Switching action	Contacts	Terminal	Part No.	Wiring diagram
Momentary	1 NO	Screw terminal	22-211.011	152
	1 NO	Plug-in terminal	22-211.014	152
	1 NC	Screw terminal	22-212.011	148
	2 NO	Screw terminal	22-213.011	155
	2 NO	Plug-in terminal	22-213.014	155
	2 NC	Screw terminal	22-214.011	154
	1 NC / 1 NO	Screw terminal	22-215.011	150
	1 NC / 1 NO	Plug-in terminal	22-215.014	150
Maintained	1 NO	Screw terminal	22-221.011	153
	1 NO	Plug-in terminal	22-221.014	153
	1 NC	Screw terminal	22-222.011	149
	2 NO	Screw terminal	22-223.011	156
	2 NO	Plug-in terminal	22-223.014	156
	1 NC / 1 NO	Screw terminal	22-225.011	151
	1 NC / 1 NO	Plug-in terminal	22-225.014	151

Contacts: NC = Normally closed, NO = Normally open

Wiring diagrams

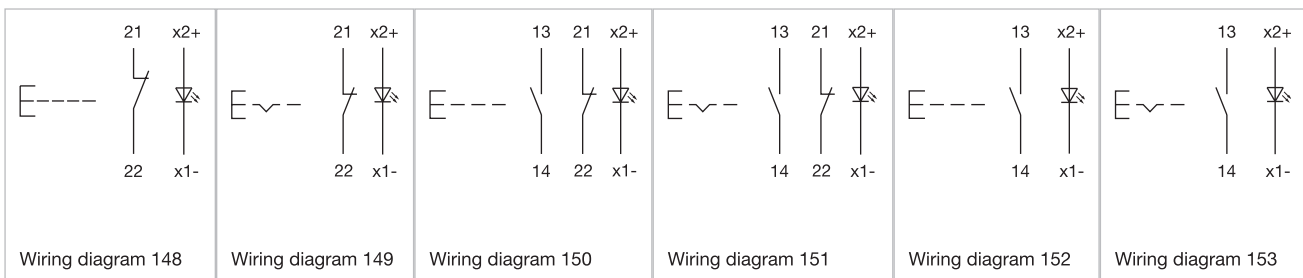

Wiring diagrams

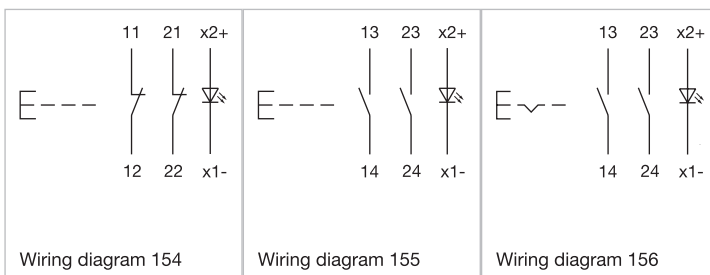

- 01
- 02
- 03
- 04
- 09
- 14
- 17
- 18
- 19
- 22**
- 31
- 41
- 45
- 51
- 56
- 57
- 61
- 70
- 71
- 82
- 84
- 92
- 96

Follow us.
We are on YouTube!
EAO ermöglicht. Seit 1947.

Come take a look at our YouTube profile today! Be sure to give us a follow so that you can fully interact with us.

<https://www.youtube.com/user/eaoswitches>

www.eao.com

Your Expert Partner for Human Machine Interfaces

22 Flush design

Keylock switch 2 positions, IP65



Product can differ from the current configuration.

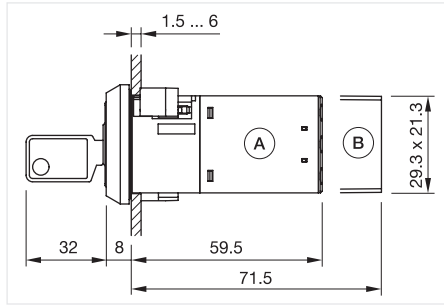

Dimensions [mm]
 A = Screw terminal
 B = Plug-in terminal 6.3 mm x 0.8 mm

Equipment consisting of (schematic overview)

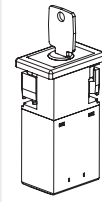

Actuator

Each Part Number listed below includes all the black components shown in the 3D-drawing.

General information

- Standard lock: DOM 311
- Front plastic black

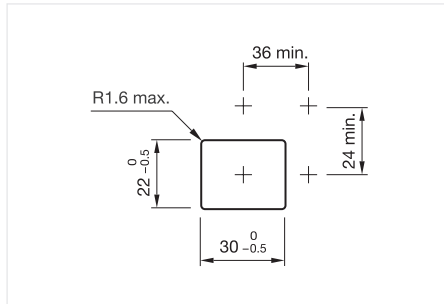

Mounting cut-outs [mm]

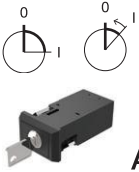

Actuator, Front dimension 36 mm x 24 mm

Switching action	Contacts	Terminal	Switching angle	Part No.	Wiring diagram
Rest (a) - Maintained (a)	1 NO	Screw terminal	90° right	22-331.511D	169
	1 NO	Plug-in terminal	90° right	22-331.514D	169
Rest (a) - Maintained	2 NO	Screw terminal	90° right	22-333.111D	170
	2 NO	Plug-in terminal	90° right	22-333.114D	170
Rest (a) - Maintained (a)	2 NO	Screw terminal	90° right	22-333.511D	170
Rest (a) - Maintained	1 NC / 1 NO	Screw terminal	90° right	22-335.111D	168
Rest (a) - Maintained (a)	1 NC / 1 NO	Screw terminal	90° right	22-335.511D	168
Rest (a) - Momentary	2 NO	Screw terminal	45° right	22-353.111D	167

Contacts: NC = Normally closed, NO = Normally open
 a = Key remove

Wiring diagrams

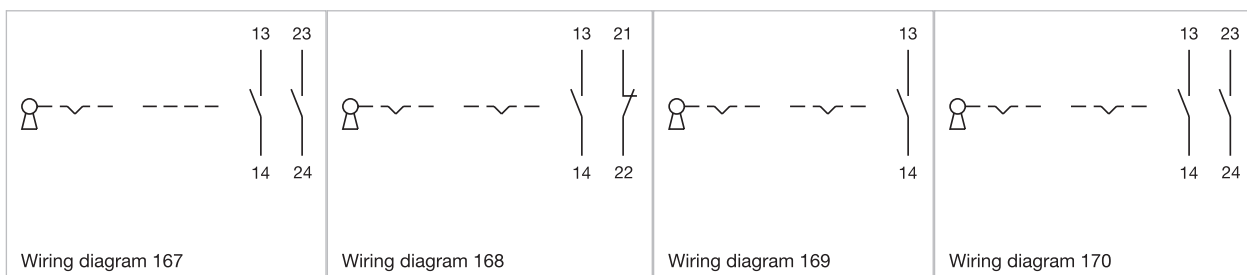

Indicator, IP65

Equipment consisting of (schematic overview)

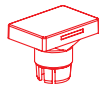

Lens

Page 436



Front bezel

Page 436



LED

Page 437

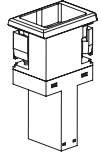

Actuator

Each Part Number listed below includes all the black components shown in the 3D-drawing.

To obtain a complete unit, please select the red components from the pages shown.

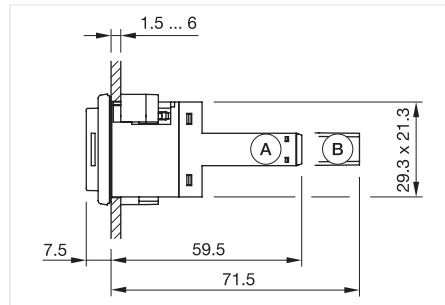

Dimensions [mm]

A = Screw terminal

B = Plug-in terminal 6.3 mm x 0.8 mm

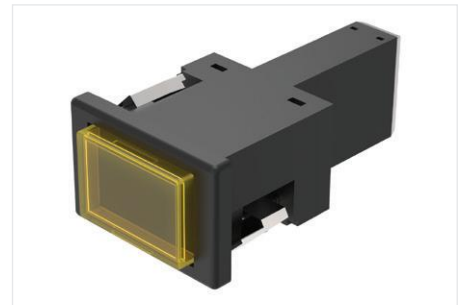

Product can differ from the current configuration.

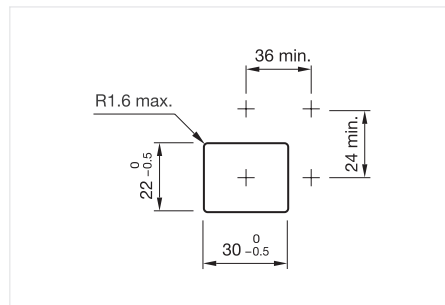

Mounting cut-outs [mm]



Actuator, Front dimension 36 mm x 24 mm

Terminal	Part No.	Wiring diagram
Screw terminal	22-040.001	4
Plug-in terminal	22-040.004	4

Wiring diagrams

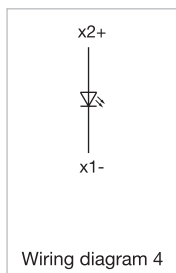

22 Components



01
02
03
04
09
14
17
18
19
22
31
41
45
51
56
57
61
70
71
82
84
92
96

Lens plastic

Lens material	Lens colour	Lens optics	Lens shape	Lens illumination	Dimensions	Part No.
Plastic	Smokey black	transparent	flush	illuminative	17 mm x 25,5 mm	22-903.1
	Red	transparent	flush	illuminative	17 mm x 25,5 mm	22-903.2
	Orange	transparent	flush	illuminative	17 mm x 25,5 mm	22-903.3
	Yellow	transparent	flush	illuminative	17 mm x 25,5 mm	22-903.4
	Green	transparent	flush	illuminative	17 mm x 25,5 mm	22-903.5
	Blue	transparent	flush	illuminative	17 mm x 25,5 mm	22-903.6
	Colourless	transparent	flush	illuminative	17 mm x 25,5 mm	22-903.7
	Black	opaque	flush	non illuminative	17 mm x 25,5 mm	22-901.0



Mushroom-head cap

Product attributes	Lens material	Lens colour	Lens optics	Lens shape	Lens illumination	Dimensions	Part No.
Use only flush front bezel	Plastic	Black	opaque	mushroom-head	non illuminative	23 mm x 35 mm	22-930.0
	Plastic	Red	opaque	mushroom-head	non illuminative	23 mm x 35 mm	22-930.2
	Plastic	Yellow	opaque	mushroom-head	non illuminative	23 mm x 35 mm	22-930.4
	Plastic	Green	opaque	mushroom-head	non illuminative	23 mm x 35 mm	22-930.5



Front bezel raised

Product attributes	Front bezel material	Front bezel colour	Dimensions	Part No.
Lens only removable with lens remover Part No. 98-969	Plastic	Black	24 mm x 36 mm	02-967.0



Front bezel flush

Product attributes	Front bezel material	Front bezel colour	Dimensions	Part No.
Lens only removable with lens remover Part No. 02-905	Plastic	Black	24 mm x 36 mm	02-965.0



Single-LED, T1 3/4 MG

Illumination colour	Operating voltage	Operation current	Lumi. Intensity	Dom. Wavelength	Part No.	Wiring diagram
Red	6 V DC +10%	15 mA ±15 %	350 mcd	630 nm	10-2J06.3142	55
	12 V AC/DC +10%	7 - 14 mA ±15 %	330 mcd	630 nm	10-2J09.1062	55
	24 V AC/DC +10%	7 - 14 mA ±15 %	330 mcd	630 nm	10-2J12.1062	55
	28 V AC/DC +10%	7 - 14 mA ±15 %	330 mcd	630 nm	10-2J13.1062	55
	48 V AC/DC +10%	4 - 8 mA ±15 %	200 mcd	630 nm	10-2J19.1042	55
Yellow	6 V DC +10%	15 mA ±15 %	300 mcd	587 nm	10-2J06.3144	55
	12 V AC/DC +10%	7 - 14 mA ±15 %	280 mcd	587 nm	10-2J09.1064	55
	24 V AC/DC +10%	7 - 14 mA ±15 %	280 mcd	587 nm	10-2J12.1064	55
	28 V AC/DC +10%	7 - 14 mA ±15 %	280 mcd	587 nm	10-2J13.1064	55
	48 V AC/DC +10%	4 - 8 mA ±15 %	180 mcd	587 nm	10-2J19.1044	55
Green	6 V DC +10%	7 mA ±15 %	1050 mcd	525 nm	10-2J06.3145	55
	12 V AC/DC +10%	4 - 7 mA ±15 %	1050 mcd	525 nm	10-2J09.1065	55
	24 V AC/DC +10%	4 - 7 mA ±15 %	1050 mcd	525 nm	10-2J12.1065	55
	28 V AC/DC +10%	4 - 7 mA ±15 %	1050 mcd	525 nm	10-2J13.1065	55
	48 V AC/DC +10%	2 - 4 mA ±15 %	600 mcd	525 nm	10-2J19.1045	55
Blue	6 V DC +10%	15 mA ±15 %	680 mcd	470 nm	10-2J06.3146	55
	12 V AC/DC +10%	4 - 14 mA ±15 %	650 mcd	470 nm	10-2J09.1066	55
	24 V AC/DC +10%	7 - 14 mA ±15 %	650 mcd	470 nm	10-2J12.1066	55
	28 V AC/DC +10%	7 - 14 mA ±15 %	650 mcd	470 nm	10-2J13.1066	55
	48 V AC/DC +10%	4 - 8 mA ±15 %	400 mcd	470 nm	10-2J19.1046	55
White	6 V DC +10%	6 mA ±15 %	900 mcd	x: 0.31 / y: 0.32 nm	10-2J06.3149	55
	12 V AC/DC +10%	3 - 6 mA ±15 %	900 mcd	x: 0.31 / y: 0.32 nm	10-2J09.1069	55
	24 V AC/DC +10%	2,5 - 5 mA ±15 %	750 mcd	x: 0.31 / y: 0.32 nm	10-2J12.1069	55
	28 V AC/DC +10%	2,5 - 5 mA ±15 %	750 mcd	x: 0.31 / y: 0.32 nm	10-2J13.1069	55
	48 V AC/DC +10%	2 - 4 mA ±15 %	600 mcd	x: 0.31 / y: 0.32 nm	10-2J19.1049	55
Red / Green	24 V AC/DC +10%	15/14 mA ±15 %	600/630 mcd	625 / 525 nm	10-A312.314A	171

Additional information

- Due to high surface temperatures, the series resistor must not be soldered directly to the terminals of the equipment (use a terminal plate)
- When using AC/DC types with AC operation, slight flickering can occur
- The luminous intensity stated is for when used with DC
- Electrical and optical data are measured at 25 °C
- The specified versions are built with a protection diode (half wave rectifier) in series and the LED
- Luminosity and wave length variations caused by LED manufacturing processes may cause slight differences regarding the illumination. The customer has to decide what resistor shall be used to the LED
- Where supply voltages are over 48 V, a voltage-reduction element (external protective series resistor) must be used.

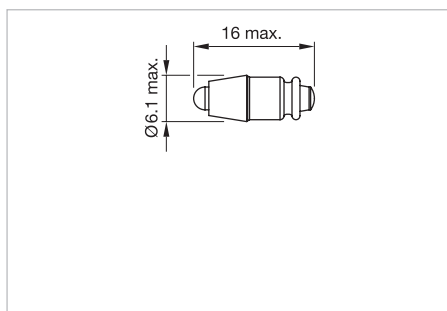

Dimensions [mm]

22 Components

Wiring diagrams

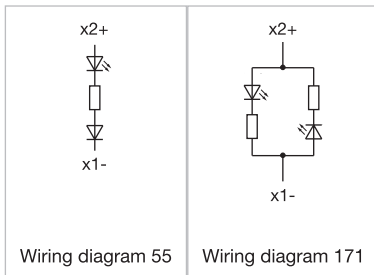

Front side



Blind plug

Dimensions	Material	Colour	Part No.
24 mm x 36 mm	plastic	Black	22-949.0



Spare key

Product attributes	Material	Part No.
Standard lock: DOM 311	metal	31-989.311



Master key

Product attributes	Material	Part No.
For standard lock: DOM 311 ... 445	metal	31-989.300



Protective cover

Material	Optics	Mounting cut-out	Part No.
Plastic	transparent	22 mm x 30 mm	22-925

Additional information

- Hinged, with means for sealing
- Please note that bigger minimum distances are necessary
- Use only flush front bezel

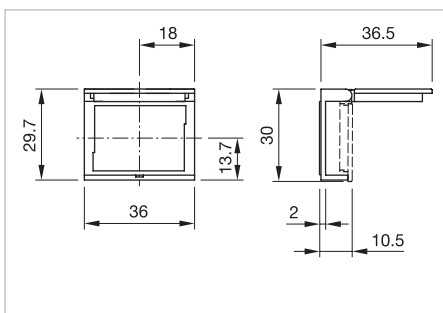

Dimensions [mm]

22 Accessories

Rear side



Side terminal plate empty

Product attributes	Dimensions	Part No.
5 spaces	62.5 mm x 15 mm x 60 mm	02-912.1
10 spaces	125 mm x 15 mm x 60 mm	02-912.2
15 spaces	187.6 mm x 15 mm x 60 mm	02-912.3
20 spaces	250 mm x 15 mm x 60 mm	02-912.4



Series resistor

Operating voltage	Resistance	Part No.
110 V AC	2.7 kOhm	02-904.0
125 V AC	3.3 kOhm	02-904.1
145 V AC	4.7 kOhm	02-904.3
240 V AC	10 kOhm	02-904.7

Additional information

- Only for filament lamp 48 VAC, 25 mA
- Due to high surface temperatures, the series resistor must not be soldered directly to the terminals of the equipment (use a terminal plate)

Mounting



Dismantling tool

Product attributes	Material	Part No.
For dismantling the lens from the holder	metal / plastic	22-938



Lens remover

Product attributes	Material	Part No.
For raised design	metal	02-905
For dismantling of the square lens, flush design	metal	98-968





Lamp remover

Product attributes	Material	Part No.
A switching action may occur when replacing the lamp	plastic	61-9740.0

01
02
03
04
09
14
17
18
19
22
31
41
45
51
56
57
61
70
71
82
84
92
96

Follow us.
We are on LinkedIn!
EAO creates possibilities. Since 1947.







[Come take a look at our LinkedIn profile today!](https://www.linkedin.com/company/eao/) Be sure to give us a follow so that you can fully interact with us.

<https://www.linkedin.com/company/eao/>

www.eao.com



Your Expert Partner for Human Machine Interfaces

22 Technical data

Actuator with snap-action switching element

Switching system

Self-cleaning, double-break, snap-action switching system (with contact gap 2 x 1.5 mm).
Max. 2 normally closed or 2 normally open contacts, or one of each.

Material

Lens
Plastic, as per UL 94 HB

Front bezel
Plastic

Material of contact
Hard silver

Actuator housing
Plastic

Mechanical characteristics

Terminals
Screw terminal (with self-lifting clip):
Max. wire cross-section 2 x 2.5 mm²
Max. wire cross-section of stranded cable 2 x 1.5 mm²

Plug-in terminal 6.3 mm x 0.8 mm

Actuating force
With 1 switching element 3.6 N ± 0.3 N
With 2 switching elements 6.8 N ± 0.3 N

Actuating travel
5.5 mm ± 0.2 mm

Travel
3 mm

Mechanical lifetime
Illuminated pushbutton 1 million operations
Keylock switch 40 000 operations

Electrical characteristics

Switching voltage and switching current
400 VAC, 4 A (induktiv, cos(phi) = 0,7)
250 VAC, 5 A (induktiv, cos(phi) = 0,7)
250 VAC, 2 A (induktiv, cos(phi) = 0,7)
125 VAC, 8 A (induktiv, cos(phi) = 0,7)
110 VDC, 0,4 A (induktiv, L:R = 30 ms)
60 VDC, 1,5 A (induktiv, L:R = 30 ms)
24 VDC, 6 A (induktiv, L:R = 30 ms)

Electric strength
2500 VAC, 50 Hz, 1 minute between all terminals and earth, as per IEC 60512-2-11.

Electrical lifetime
50 000 cycles of operation

Ambient conditions

Storage temperature
-40 °C ... +95 °C

Operating temperature
-25 °C ... +85 °C for the switch body and
up to +55 °C for the actuating part

Protection degree
IP20 terminal/case
IP65 front side, as per IEC 60529

Shock resistance
50 g for 11 ms, as per IEC 60512-4-3

Vibration resistance
(sinusoidal)
10 g at 10 Hz ... 2000 Hz, amplitude 0.75 mm,
as per IEC 60512-4-4

Approvals

Approbations
CB (IEC 61058-1)
CSA
ENEC (EN 61058-1)
UL

Conformities
CE
UKCA
2014/35/EU (LVD)
2011/65/EC (RoHS)

General notes

1. Engraving

In addition to the most commonly used world languages, in DIN1451-3 close spacing, other typefaces are available as Scandinavian, Slavic, Greek, Russian and Polish. Red, blue and black lenses are filled with white colour. Other colour lenses are filled in black. Standard height of letters is 3 mm. If the height is not specified, we will supply 3 mm engraved letters.

2. Hot stamping

For larger series it is worth considering markings by means of hot stamping. We will be pleased to advise you.

3. Film inserts

Instead of using engraving the lenses can be fitted with transparent film inserts, as an alternative. For this purpose, though, it is advisable to use transparent lenses. In the case of use of a smoke-black lens the fitted film becomes readable only if the lamp is on. The film thickness is 0.2 mm.

Important: Consider pushbutton mounting orientation before specifying engraving characters!

Engraving film insert

All dimensions in mm

Film insert max. dimensions	Height of letters h	Number of lines	Number of capital letters per line (guide value)	Number of lowercase letters per line (guide value)	Picture
14.3 x 22.4	3	3	9	10	B1
	4	2	7	8	B1
	5	2	5	6	B1
	6	1	4	5	B1
	8	1	3	4	B1
	3	5	6	6	B2
	4	4	4	5	B2
	5	3	3	4	B2
	6	2	3	3	B2
	8	2	2	2	B2

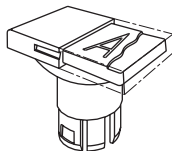
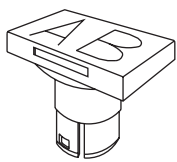

B1

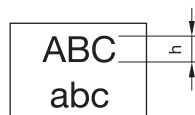

B2

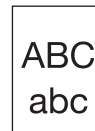

The gap between two words results in each case a letter less.

22 Marking

Engraving lens

All dimensions in mm

Lens	Height of letters h	Number of lines	Number of capital letters per line (guide value)	Number of lowercase letters per line (guide value)	Picture
17.5 x 25.5	3	4	10	11	B1
	4	3	8	9	B1
	5	2	6	7	B1
	6	2	5	6	B1
	8	1	4	4	B1
	3	6	7	8	B2
	4	4	5	6	B2
	5	4	4	5	B2
	6	3	3	4	B2
	8	2	3	3	B2

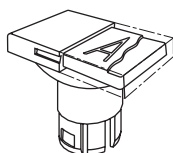
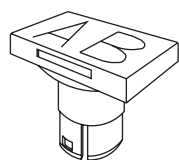

B1

B2

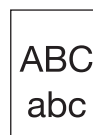
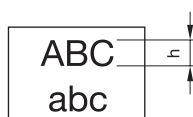

The gap between two words results in each case a letter less.

Suppressor circuits

When switching inductive loads such as relays, DC motors, and DC solenoids, it is always important to absorb surges (e.g. with a diode) to protect the contacts. When these inductive loads are switched off, a counter emf can severely damage switch contacts and greatly shorten lifetime.

Fig. 1 shows an inductive load with a free-wheeling diode connected in parallel. This free-wheeling diode provides a path for the inductor current to flow when the current is interrupted by the switch. Without this free-wheeling diode, the voltage across the coil will be limited only by dielectric breakdown voltages of the circuit or parasitic elements of the coil. This voltage can be kilo-

volts in amplitude even when nominal circuit voltages are low (e.g. 12 VDC) see Fig. 2.

The free-wheeling diode should be chosen so that the reverse breakdown voltage is greater than the voltage driving the inductive load. The DC blocking voltage (V_R) of the free-wheeling diode can be found in the datasheet of a diode. The forward current should be equal or greater than the maximum current flowing through the load.

To get an efficient protection, the free-wheeling diode must be connected as close as possible to the inductive load!

Switching with inductive load
Fig. 1

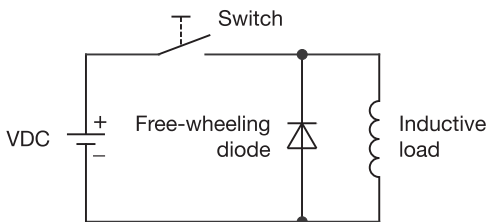

Counter EMF
over load without free-wheeling diode
Fig. 2

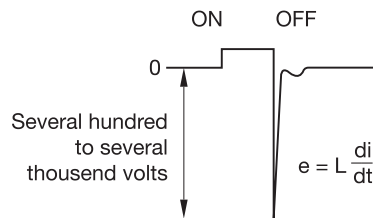

01
02
03
04
09
14
17
18
19
22
31
41
45
51
56
57
61
70
71
82
84
92
96

