

Pendant light fitting

Series 6050/1, Series 6050/3

STAHL



- > Saltwater-resistant enclosure, aluminium alloy, optionally with painting
- > Mounting with ring bolts or tiltable mounting bracket
- > With connection box for easy installation
- > IP68 (10 m depth of immersion for 30 min) at size 1

E2

www.stahl.de



10336E00

| | ATEX / IECEx | | | | | |
|------------|--------------|---|---|----|----|----|
| Zone | 0 | 1 | 2 | 20 | 21 | 22 |
| For use in | | x | x | | x | x |

Explosion Protection

Global (IECEx)

Gas and dust

IECEx PTB 06.0049X
Ex d e IIC T3, T4, T5, T6 ¹⁾ Gb
Ex tb IIIC T80 ... T170°C ¹⁾ Db

Europe (ATEX)

Gas and dust

PTB 03 ATEX 1096
⊕ II 2 G Ex d e IIC T3, T4, T5, T6 ¹⁾ Gb
⊕ II 2 D Ex tb IIIC T80 ... T170°C ¹⁾ Db
¹⁾ See selection table

Certifications and certificates

Certificates

IECEx, ATEX, China (China-Ex), India (PESO), Kazakhstan (TR), Russia (TR), Ukraine (TR), Belarus (TR)

Ship approval

GL

WebCode 6050A

Pendant light fitting

Series 6050/1, Series 6050/3

Selection Table

| Version | Lamps ¹⁾ | Lamp holder | Lamp wattage | Temperature class at Ta = | | T _{S max} at Ta = 40 °C | Order number | Weight kg |
|---|---------------------|-------------|--------------|---------------------------|-------|----------------------------------|------------------------|--------------|
| | | | | 40 °C | 50 °C | | | |
| Pendant light fitting Series 6050, size 1 up to 250 W; Zone 1, 21 | QT | E27 | 150 W | T4 | T4 | 116 °C | 6050/11...-11510-.0.-1 | 10.700 |
| | | | 205 W | T3 | -- | 142 °C | 6050/11...-12510-.0.-1 | 10.800 |
| | HIE | E27 | 70 W | T5 | T4 | 95 °C | 6050/11...-2071-.0.-1 | 10.700 |
| | | | 100 W | T4 | T4 | 115 °C | 6050/11...-2101-.0.-1 | 11.100 |
| | | | 150 W | T4 | | 130 °C | 6050/11...-2151-.0.-1 | 12.100 |
| | HSE | E27 | 50 W | T5 | T4 | 90 °C | 6050/11...-3051-.0.-1 | 10.250 |
| 70 W | | | T5 | T4 | 95 °C | 6050/11...-3071-.0.-1 | 10.700 | |

Order Number Supplement

| | | | |
|-----------------------------------|--|----------------------|-------|
| Suspension | two insert threads M8 in the cover of the light fitting | 6050/111-..... | |
| | with additional mounting bracket (for ceiling and wall mounting) | 6050/112-..... | 2.100 |
| Cable entries (in connection box) | 2 x M25 x 1.5 (standard) → 1 x cable entry, 1 x stopping plug | 6050/11.1-..... | |
| | 2 x M20 x 1.5 → 1 x cable entry, 1 x stopping plug | 6050/11.2-..... | 0.560 |
| | 2 x NPT ¾" → 2 x threaded holes | 6050/11.3-..... | |
| | 2 x NPT 1" → 2 x threaded holes | 6050/11.4-..... | |
| Compensation | without compensation | 6050/11.....0-..... | |
| | with compensation | 6050/11.....1-..... | |
| Wire guard | without wire guard | 6050/11.....-0-..... | |
| | with wire guard | 6050/11.....-1-..... | 0.560 |
| Switch-off on opening | without switch | 6050/11.....-0- | |
| Voltage | AC: 230 V ±6 %; 50 Hz | 6050/11.....-1 | |
| | AC: 240 V ±6 %; 50 Hz | 6050/11.....-4 | |

- Notes:**
- ¹⁾ QT → Halogen lamp
HIE → Metal halide lamp
HSE High-pressure sodium lamp
- The pendant light fitting is unpainted; painting is possible (on request)
 - The pendant light fittings are supplied without lamps (see Accessories)
 - External reflector (see Accessories)

Pendant light fitting

Series 6050/1, Series 6050/3

Selection Table

| Version | Lamps ¹⁾ | Lamp holder | Lamp wattage | Temperature class at Ta = | | T _{Smax} at Ta = 40 °C | Order number | Weight | |
|---|---------------------|-------------|--------------|---------------------------|-------|---------------------------------|------------------------|-----------------------|--------|
| | | | | 40 °C | 50 °C | | | | |
| | | | | kg | | | | | |
| Pendant light fitting Series 6050, size 3 up to 500 W; Zone 1, 21 | QT | E40 | 205 W | T3 | -- | 142 °C | 6050/31...-12520-.0.-1 | 29.000 | |
| | HIE | E40 | 250 W | T4 | -- | 110 °C | 6050/31...-2252-.0.-1 | 29.000 | |
| | | | 400 W | T4 | -- | 127 °C | 6050/31...-2402-.0.-1 | 29.000 | |
| | HSE | E40 | 150 W | T5 | T4 | -- | 90 °C | 6050/31...-3152-.0.-1 | 29.000 |
| | | | 250 W | T4 | -- | 110 °C | 6050/31...-3252-.0.-1 | 29.000 | |
| | | | 400 W | T4 | -- | 130 °C | 6050/31...-3402-.0.-1 | 29.000 | |

Order Number Supplement

| | | | |
|-----------------------------------|--|-------------------------|-------|
| Suspension | two insert threads M10 in the cover of the light fitting | 6050/311...-..... | |
| | with additional mounting bracket (for ceiling and wall mounting) | 6050/312...-..... | 4.000 |
| Cable entries (in connection box) | 2 x M25 x 1.5 (standard) → 1 x cable entry, 1 x stopping plug | 6050/31.1-..... | |
| | 2 x M20 x 1.5 → 1 x cable entry, 1 x stopping plug | 6050/31.2-..... | |
| | 2 x NPT ¾" → 2 x threaded holes | 6050/31.3-..... | |
| | 2 x NPT 1" → 2 x threaded holes | 6050/31.4-..... | |
| Compensation | without compensation | 6050/31...-.....0-..... | |
| | with compensation | 6050/31...-.....1-..... | |
| Wire guard | without wire guard | 6050/31...-.....0...- | |
| | with wire guard | 6050/31...-.....1...- | 1.450 |
| Switch-off on opening | without switch | 6050/31...-.....0-.. | |
| Voltage | AC: 230 V ±6 %; 50 Hz | 6050/31...-.....-1 | |
| | AC: 240 V ±6 %; 50 Hz | 6050/31...-.....-4 | |

- Notes:**
- ¹⁾ QT → Halogen lamp
 - HIE → Metal halide lamps
 - HSE → High-pressure sodium lamps
 - The pendant light fitting is unpainted; painting is possible (on request)
 - The pendant light fittings are supplied without lamps (see Accessories)
 - External reflector (see Accessories)

Pendant light fitting

Series 6050/1, Series 6050/3

Technical Data

Electrical data

| | | | | | |
|------------------------------------|--|--------------|------------|--|---------------------|
| Rated operational voltage U_e | 6050/.....-1: 230 V AC ($\pm 6\%$), 50 Hz 6050/.....-4: 240 V AC ($\pm 6\%$), 50 Hz | | | | |
| Rated current | Lamp type *) | Lamp holder | Wattage | Luminous flux | I_N (compensated) |
| | QT | E27 | 150 W | 2870 lm | 0.65 A |
| | | E40 | 205 W | 4200 lm | 0.95 A |
| | | E40 | 500 W | 10250 lm | 2.27 A |
| | HIE | E27 | 70 W | 5100 lm | 0.43 A |
| | | E27 | 100 W | 7700 lm | 0.55 A |
| | | E27 | 150 W | 11500 lm | 0.80 A |
| | | E40 | 250 W | 19000 lm | 1.35 A |
| | | E40 | 400 W | 34000 lm | 2.10 A |
| | HSE | E27 | 50 W | 4000 lm | 0.30 A |
| | | E27 | 70 W | 5600 lm | 0.38 A |
| | | E40 | 150 W | 15000 lm | 0.80 A |
| | | E40 | 250 W | 27000 lm | 1.35 A |
| | | E40 | 400 W | 48000 lm | 1.97 A |
| | *) QT | Halogen lamp | HSE HIE | High-pressure sodium lamp Metal halide lamp | |
| Power factor | Nominal current compensated gas discharge lamps ($\lambda > 0.9$) $\cos \varphi \geq 0.9$ (compensated) | | | | |
| Disconnection of the light | 2-pole; when opening safety glass cover (option) | | | | |

Ambient conditions

| Ambient temperature | | Gas-Ex-area | | Dust-Ex-area |
|---------------------|--------|-------------|----------------|----------------|
| Size 1 | QT | 150 W | -60 ... +50 °C | -50 ... +50 °C |
| | | 250 W | -60 ... +40 °C | -50 ... +40 °C |
| | HIE | 70 W | -60 ... +50 °C | -50 ... +50 °C |
| | | 100 W | -60 ... +50 °C | -50 ... +50 °C |
| | | 150 W | -60 ... +40 °C | -50 ... +40 °C |
| | HSE | 50 W | -60 ... +50 °C | -50 ... +50 °C |
| | | 70 W | -60 ... +50 °C | -50 ... +50 °C |
| | Size 3 | QT | 250 W | -20 ... +40 °C |
| HIE | | 250 W | -20 ... +40 °C | |
| | | 400 W | -20 ... +40 °C | |
| HSE | | 150 W | -20 ... +50 °C | |
| | | 250 W | -20 ... +40 °C | |
| | | 400 W | -20 ... +40 °C | |

Mechanical data

| | |
|----------------------|--|
| Degree of protection | IP66; IP68 size 1 only (IEC 60598) |
| Protection class | I (internal + external PE / PA connection) |
| Material | |
| Enclosure material | Light metal |
| Protective glass | Temperature-resistant pressed glass |
| Cover seal | Silicon |
| Internal reflector | High-polished aluminium |
| External reflector | Highest grade aluminium |
| Wire guard | Steel wire (stainless steel) |
| Enclosure lock | M 4, Torx screw head |

Pendant light fitting

Series 6050/1, Series 6050/3







Technical Data

Mounting / Installation

| | |
|-----------------------------------|--|
| Position of normal use | Pendant mounting or slewing range $\pm 40^\circ$ |
| Cable entry | |
| Standard | 2 x M25 x 1.5; 1 x cable entry $\varnothing 7 \dots 17$ mm, 1 x stopping plug |
| Special | - 2 x M20 x 1.5; 1 x cable entry $\varnothing 6$ to 13 mm, 1 x stopping plug - 2 x NPT $\frac{3}{4}$ " threaded holes - 2 x NPT 1" threaded holes |
| Connection option | L1 + N + PE for 4 mm ² solid / finely stranded |
| Mounting | via 2 x M 8 / 2 x M 10 thread inserts in the cover of the light fitting alternatively: via additional mounting bracket (stainless steel), adjustable in 10° steps |
| Wire guard and external reflector | can easily be mounted later using an M6 mounting screw |

E2







Accessories and Spare Parts

| Designation | Illustration | Description | | | | Art. no. | Weight kg | |
|---|---|-----------------------------------|-------------|---------|---------------|---------------|---------------|-------|
| | | Power | Lamp holder | Voltage | Light current | | | |
| Halogen lamp QT |  05355E00 | 150 W | E27 | 230 V | 2870 lm | 207458 | 0.080 | |
| | | 205 W | E27 | 230 V | 4200 lm | 203469 | 0.100 | |
| | | 500 W | E40 | 230 V | 10250 lm | 108874 | 0.120 | |
| High-pressure sodium lamp HSE |  04963E00 | 70 W | E27 | 230 V | 5600 lm | 109105 | 0.054 | |
| | | 150 W | E40 | 230 V | 14500 lm | 108900 | 0.285 | |
| | | 250 W | E40 | 230 V | 27000 lm | 108901 | 0.173 | |
| | | 400 W | E40 | 230 V | 48000 lm | 108903 | 0.235 | |
| High-pressure sodium lamp HSE (TwinArc) |  04963E00 | 50 W | E27 | 230 V | 4000 lm | 109493 | 0.070 | |
| | | 70 W | E27 | 230 V | 6500 lm | 109494 | 0.059 | |
| | | 150 W | E40 | 230 V | 17000 lm | 109496 | 0.160 | |
| | | 250 W | E40 | 230 V | 32000 lm | 109497 | 0.195 | |
| | | 400 W | E40 | 230 V | 55000 lm | 109498 | 0.237 | |
| Metal halide lamp HIE |  04963E00 | 70 W | E27 | 230 V | 5100 lm | 109307 | 0.073 | |
| | | 100 W | E27 | 230 V | 7700 lm | 109308 | 0.101 | |
| | | 150 W | E27 | 230 V | 11500 lm | 109309 | 0.110 | |
| | | 250 W | E40 | 230 V | 19000 lm | 108884 | 0.200 | |
| | | 400 W | E40 | 230 V | 34000 lm | 108885 | 0.242 | |
| Protective glass |  10291E00 | Protective glass with fixing-ring | | | | | | |
| | | | | | | for 6050/11 | 118569 | 3.380 |
| | | | | | | for 6050/31 | 118577 | 7.892 |

Pendant light fitting

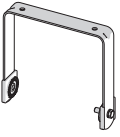
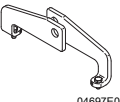
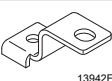
Series 6050/1, Series 6050/3

Accessories and Spare Parts

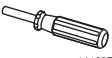
| Designation | Illustration | Description | Art. no. | Weight kg |
|-------------------------------|---|--|---------------|--------------|
| External reflector |  10288E00 | Complete with mounting parts Material: high-polished aluminium for 6050/11 and 6050/51, spot beam | 118558 | 0.216 |
| | | for 6050/31, broad beam | 118572 | 0.670 |
| | | for 6050/11 and 6050/51, broad beam | 118565 | 0.150 |
| Wire guard |  10289E00 | Complete with mounting parts Material: steel wire, stainless steel for 6050/11 | 118554 | 0.560 |
| | | for 6050/31 | 118561 | 1.450 |
| Mounting bracket |  10287E00 | Complete; stainless steel (for additional mounting) for 6050/11 and 6050/51 | 118557 | 2.100 |
| | | for 6050/31 | 118564 | 4.000 |
| Single-point mounting fixture |  04697E00 | The stainless steel mounting fixture is fastened to the enclosure of the pendant light fitting Series 6050 by means of two stainless steel screws M8. for 6050/11 and 6050/51 | 118571 | 0.374 |
| | | for 6050/31 | 118574 | 0.600 |
| Ceiling mount |  13942E00 | For direct installation of the light on the ceiling for 6050/11 and 6050/51 1 pair | 167641 | 0.150 |
| | | for 6050/31 1 pair | 167643 | 0.200 |
| Ring bolt |  05378E00 | M8, direct mounting in insert nuts, 1 pair | 115736 | 0.112 |
| | | M10, direct mounting in insert nuts, 1 pair | 118560 | 0.210 |
| Cable gland |  02055E00 | of moulded material, Series 8161 8161/7-M25-1707 7 ... 17 mm ² 50 pieces (delivery lot ^{*)} | 239157 | 1.000 |
| | | 8161/7-M20-1304 4 ... 13 mm ² 50 pieces (delivery lot ^{*)} | 239156 | 0.600 |
| Stopping plug |  04840E00 | of moulded material, Series 8290 8290/3-M20 1 piece | 143522 | 0.005 |
| | | 8290/3-M20 100 pieces | 143543 | 0.500 |
| | | 8290/3-M25 x 1,5 1 pieces | 143524 | 0.007 |
| | | 8290/3-M25 100 pieces | 143544 | 0.700 |
| Rotary actuator |  14162E00 | To tighten the protective glass 2 pieces | 203994 | 0.150 |

Pendant light fitting

Series 6050/1, Series 6050/3



Dimensional Drawings (All Dimensions in mm) – Subject to Alterations

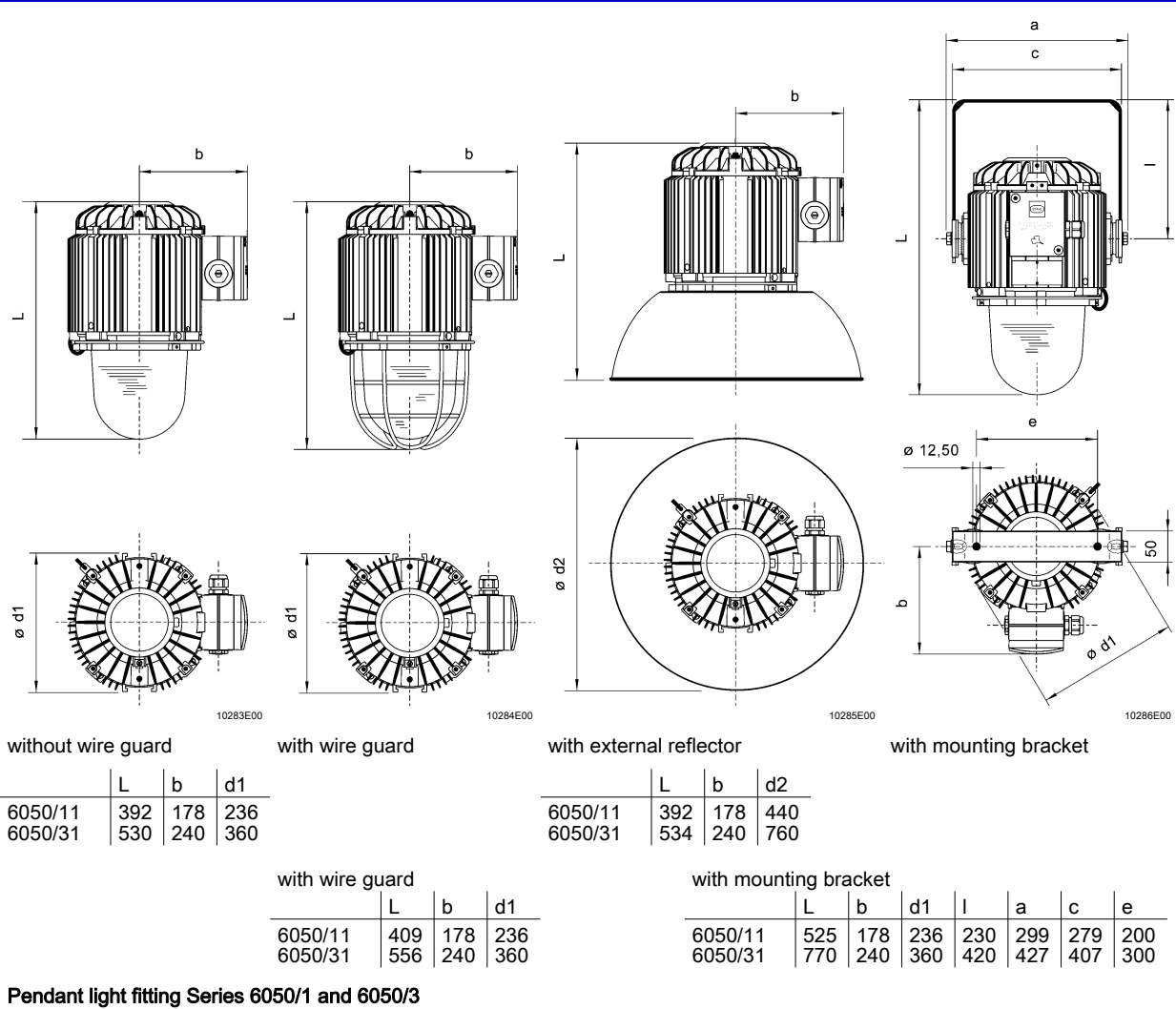

Pendant light fitting Series 6050/1 and 6050/3

We reserve the right to make alterations to the technical data, dimensions, weights, designs and products available without notice. The illustrations cannot be considered binding.

E2