

Pressure and differential pressure measuring transducers ($\pm 1.5\%$), including connection set, calibratable, with multi-range switching and active output

Quality product for HVAC sector, accuracy $\pm 1.5\%$

The calibratable **PREMASGARD® 7110** compact pressure sensors (series) are equipped with eight switchable measuring ranges and equipped with optional display (eight devices in one) and are used to measure above-atmospheric, below-atmospheric, or differential pressures in air. The piezoresistive measuring element is temperature-compensated and guarantees a high degree of reliability and precision. The pressure transmitters feature a pushbutton for manual zero point calibration or an automatic zero point calibration function as well as an adjustable offset.

Applications of these pressure sensors are in clean room, medical and filter technology, in ventilation and air conditioning ducts, in spray booths, in large-scale catering facilities, for monitoring filters, for level measurement or for triggering frequency converters. Media measured with these pressure transducers are clean air (non-precipitating), or other gaseous non-aggressive, non-combustible media. The pressure sensor has eight selectable measuring ranges, thereby minimising the diversity of types and inventory levels while covering a greater range of applications. The differential pressure sensor is supplied including connection set **ASD-06** (2 m connection hose, two pressure connection nipples, screws).

PREMASGARD® 7110



TECHNICAL DATA

Power supply:	24 V AC ($\pm 20\%$); 15...36 V DC for U variant 15...36 V DC for I variant, depending on working resistance, residual ripple stabilised $\pm 0.3V$
Working resistance:	$R_a(\text{ohm}) = (U_b - 14V) / 0.02A$ for I variant
Load resistance:	$R_L > 5k\Omega$ for U variant
Power consumption:	$< 2VA / 24V DC, < 3.5VA / 24V AC$
Measuring ranges:	multi-range switching with 8 switchable measuring ranges (see table)
Output signal:	0 -10V or 4...20mA
Electrical connection:	2- or 3-wire connection
Media temperature:	0...+50°C
Pressure connection:	4 / 6 x 11 mm (hoses $\varnothing = 4 / 6$ mm), metal pressure connection nozzles
Type of pressure:	differential pressure
Medium:	clean air and non-aggressive, non-combustible gases
Accuracy:	$\pm 1.5\%$ of final value (at +20°C) $\pm 3\%$ of final value for device types with max. pressure range $< \pm 250Pa$ but min. $\pm 1Pa$
Sum of Linearity+hysteresis:	$< \pm 1\%$ of final value $\pm 2\%$ of final value for pressure ranges $< \pm 250Pa$
Temperature drift values:	$\pm 0.1\% / ^\circ C$ $\pm 0.3\% / ^\circ C$ for pressure ranges $< 250Pa$
Zero point offset:	$< \pm 0.7\%$ of final value $\pm 1.4\%$ of final value for pressure ranges $< 250Pa$
Above- / below-atmospheric pressure:	max. $\pm 100hPa$
Signal filtering:	switchable 1s / 10s
Enclosure:	plastic, material polyamide, 30% glass-globe reinforced, with quick-locking screws (slotted / Phillips head combination), colour traffic white (similar to RAL 9016), enclosure cover for display is transparent!
Dimensions:	126 x 90 x 50 mm (Tyr2)
Electrical connection:	0.14-1.5 mm ² , via plug-in screw terminal
Cable gland:	M16x1.5; including strain relief
Air humidity:	$< 95\%$ r. H., non-precipitating air
Protection class:	III (according to EN 60 730)
Protection type:	IP65 (according to EN 60 529)
Standards:	CE conformity according to EMC Directive 2014 / 30 / EU, according to EN 61326-1, according to EN 61326-2-3
Equipment:	three-line display with illumination , cutout approx. 70 x 40 mm (W x H), for displaying ACTUAL pressure and for adjusting the automatic zero point calibration

ACCESSORIES

ASD-06	Connection set (nipple straight) – (included in the scope of delivery)
ASD-07	Connection nipple (at 90° angle)
DAL-02	Pressure outlet for ceiling or in-wall installation (e.g. in clean rooms)
WS-03	Weather and sun protection, 200 x 180 x 150 mm, stainless steel

Display
Automatic zero point calibration

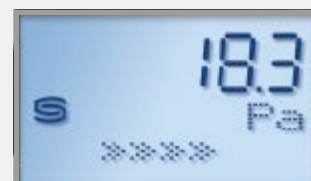

Standard
Actual pressure (in Pa)
Calibration interval (arrows)

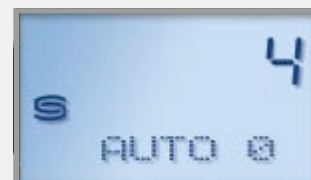

Zero point calibration Active
Calibration time (in seconds)

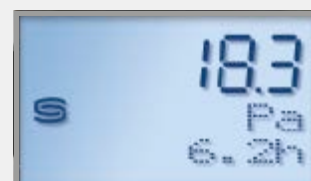

Adjustment of zero point calibration
Cycle time (15 min to 24 hours)
adjustable by potentiometer



Pressure and differential pressure measuring transducers ($\pm 1.5\%$), including connection set, calibratable, with multi-range switching and active output



Dimensional drawing

PPREMASGARD® 7110

PREMASGARD® 7110 with display

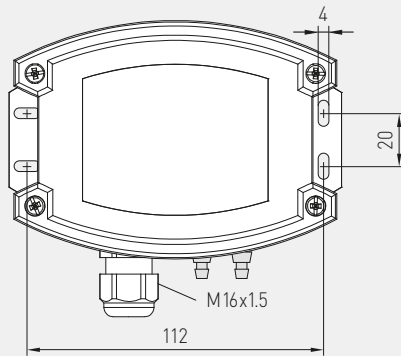
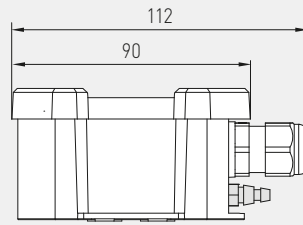
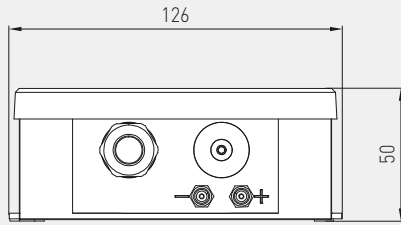

Dimensional drawing

ASD-06 Connection set

Dimensional drawing

ASD-07 Connection nipple

Dimensional drawing

DAL-02 Pressure outlet

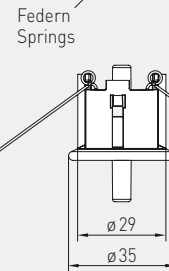
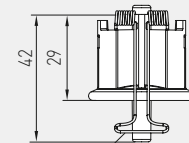
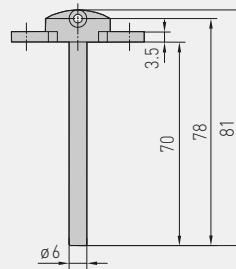
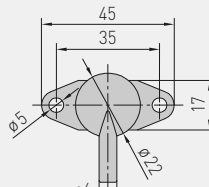
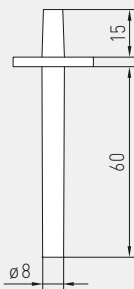
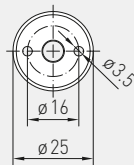

ASD-06 Connection set

ASD-07 Connection nipple

DAL-02 Pressure outlet



Pressure and differential pressure measuring transducers ($\pm 1.5\%$), including connection set, calibratable, with multi-range switching and active output

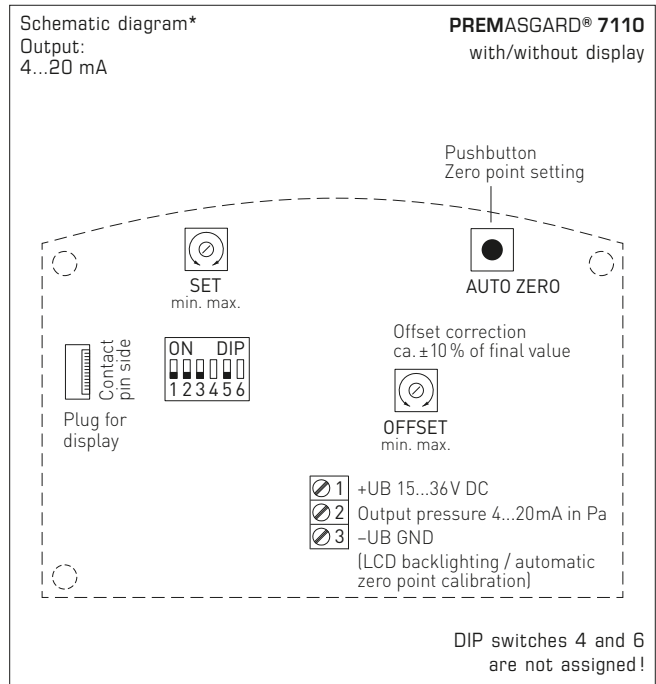
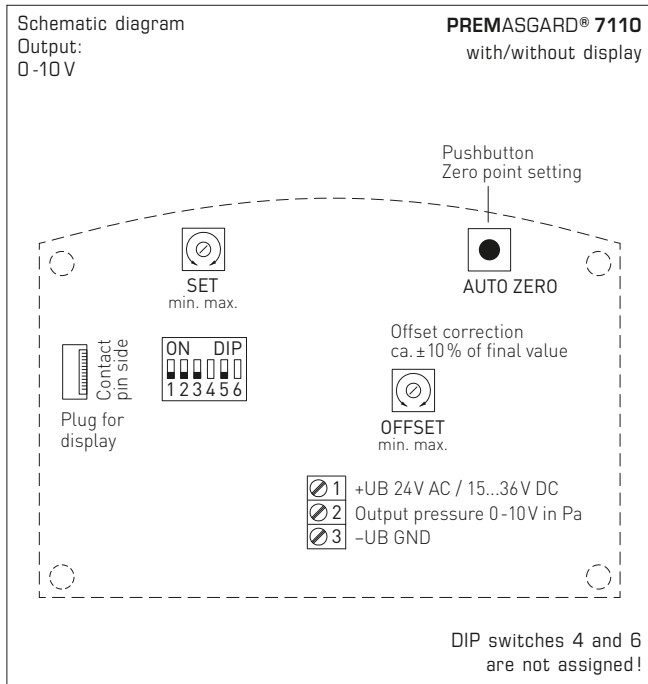

Pressure range
(adjustable, maximum measuring range depending on type of device)

0...25 Pa	0...100 Pa	0...1000 Pa	0...5000 Pa	-25...+25 Pa	-100...+100 Pa	-1000...+1000 Pa	-5000...+5000 Pa	DIP 1	DIP 2
0...25 Pa	0...50 Pa	0...100 Pa	0...1000 Pa	-25...+25 Pa	-50...+50 Pa	-100...+100 Pa	-1000...+1000 Pa	OFF	OFF
-	0...100 Pa	0...300 Pa	0...2000 Pa	-	-100...+100 Pa	-300...+300 Pa	-2000...+2000 Pa	ON	OFF
-	-	0...500 Pa	0...3000 Pa	-	-	-500...+500 Pa	-3000...+3000 Pa	OFF	ON
-	-	0...1000 Pa	0...5000 Pa	-	-	-1000...+1000 Pa	-5000...+5000 Pa	ON	ON

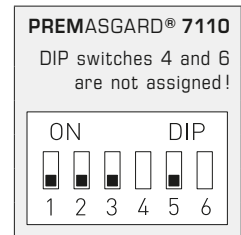

Measuring range mode (Mode selectable)	DIP 3
Unidirectional (0...+MR)	OFF
Bidirectional (-MR...+MR)	ON

Output damping (Strength and length-adjustable)	DIP 5
Long (10 s)	OFF
Small (1 s)	ON

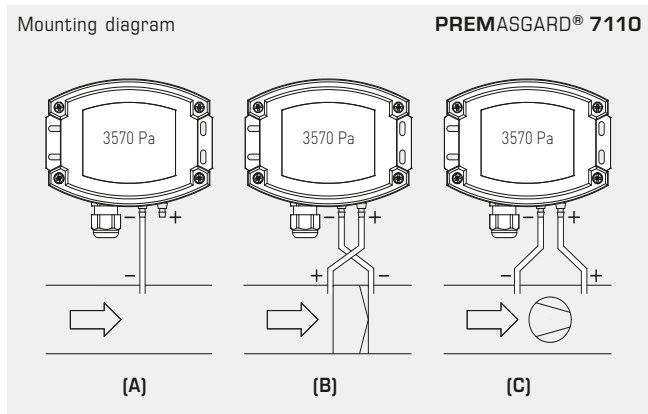

TYPES OF MONITORING:

- (A) **Below-atmospheric pressure:**
P1 (+) is not connected but open against atmosphere
P2 (-) connected to inside of duct
- (B) **Filter:**
P1 (+) connected upstream of filter
P2 (-) connected downstream of filter
- (C) **Ventilator:**
P1 (+) connected downstream of ventilator
P2 (-) connected upstream of ventilator

Pressure connections at the pressure switch are marked with P1 (+) for higher pressure and P2 (-) for lower pressure.

Conversion table for pressure values:

Unit =	bar	mbar	Pa	kPa	mH ₂ O
1 Pa	0.00001 bar	0.01 mbar	1 Pa	0.001 kPa	0.000101971 mH ₂ O
1 kPa	0.01 bar	10 mbar	1000 Pa	1 kPa	0.101971 mH ₂ O
1 bar	1 bar	1000 mbar	100000 Pa	100 kPa	10.1971 mH ₂ O
1 mbar	0.001 bar	1 mbar	100 Pa	0.1 kPa	0.0101971 mH ₂ O
1 mH ₂ O	0.0980665 bar	98.0665 mbar	9806.65 Pa	9.80665 kPa	1 mH ₂ O

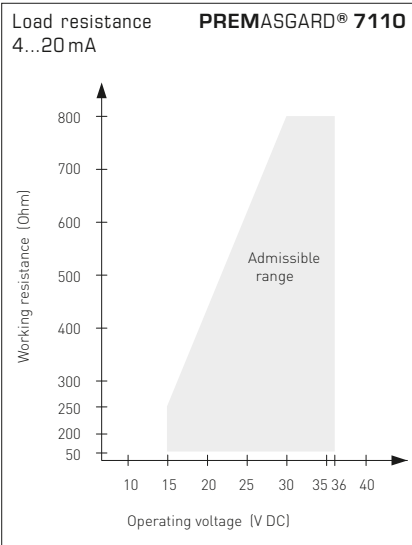

PREMASGARD® 7110 with display



PREMASGARD® 7110 – Pressure and differential pressure measuring transducers ($\pm 1.5\%$), *Deluxe*

Pressure range (Ranges adjustable)	Type / WG02	Output	Display	Item No.	Price
max. - 1000...+ 1000 Pa					
0... 100 Pa / - 100... + 100 Pa	PREMASGARD 7110	0-10V		1301-7111-0010-200	141,78 €
0... 300 Pa / - 300... + 300 Pa	PREMASGARD 7110 DISPLAY	0-10V	■	1301-7111-4010-200	198,90 €
0... 500 Pa / - 500... + 500 Pa	PREMASGARD 7110	4 ... 20 mA		1301-7112-0010-100	141,78 €
0... 1000 Pa / -1000... + 1000 Pa	PREMASGARD 7110 DISPLAY	4 ... 20 mA	■	1301-7112-4010-100	198,90 €
max. - 5000...+ 5000 Pa					
0... 1000 Pa / - 1000 ... + 1000 Pa	PREMASGARD 7110	0-10V		1301-7111-0050-200	141,78 €
0... 2000 Pa / - 2000 ... + 2000 Pa	PREMASGARD 7110 DISPLAY	0-10V	■	1301-7111-4050-200	198,90 €
0... 3000 Pa / - 3000 ... + 3000 Pa	PREMASGARD 7110	4 ... 20 mA		1301-7112-0050-100	141,78 €
0... 5000 Pa / - 5000 ... + 5000 Pa	PREMASGARD 7110 DISPLAY	4 ... 20 mA	■	1301-7112-4050-100	198,90 €
max. -100...+100 Pa					
0... +50 Pa / -50... +50 Pa	PREMASGARD 7110	0-10V		1301-7111-0110-200	178,50 €
0...+100 Pa / -100...+100 Pa	PREMASGARD 7110 DISPLAY	0-10V	■	1301-7111-4110-200	229,50 €
	PREMASGARD 7110	4 ... 20 mA		1301-7112-0110-100	178,50 €
	PREMASGARD 7110 DISPLAY	4 ... 20 mA	■	1301-7112-4110-100	229,50 €
max. -25...+25 Pa					
	Equipped as standard with automatic zero point calibration (3-wire connection)				
0... +25 Pa / -25... +25 Pa	PREMASGARD 7110	0-10V		1301-7111-0370-200	228,48 €
	PREMASGARD 7110 DISPLAY	0-10V	■	1301-7111-4370-200	270,51 €
	PREMASGARD 7110	4 ... 20 mA		1301-7112-0370-200	228,48 €
	PREMASGARD 7110 DISPLAY	4 ... 20 mA	■	1301-7112-4370-200	270,51 €
Multi-range switching:	Depending on the type of device, altogether eight pressure ranges can be preset via DIP switches. (Factory setting is maximum measuring range)				
Extra charge:	Other special measuring ranges up to max. 5000 Pa with optional automatic zero point calibration (please specify in your order)				42,02 € 61,20 €

Accessories					
ASD-06	Connection set (included in the scope of delivery) , consisting of 2 connection nipples (straight) made of ABS, 2 m PVC hose, soft, and 4 tapping screws			7100-0060-3000-000	6,45 €
ASD-07	2 connection nipples (at 90 degree angle) made of plastic, ABS			7100-0060-7000-000	6,45 €
DAL-02	Pressure outlet for ceiling or in-wall installation (e.g. in clean rooms)			7300-0060-3000-100	30,18 €
WS-03	Weather and sun protection , 200 x 180 x 150 mm, stainless steel			7100-0040-6000-000	37,74 €

For further information, see last chapter Accessories!