

MAGNEHELIC® DIFFERENTIAL PRESSURE GAGES

Indicate Positive, Negative or Differential, Accurate within 1%



Standard Magnehelic® Gage



High Accuracy Magnehelic® Gage
Note: Shown with optional -SS bezel

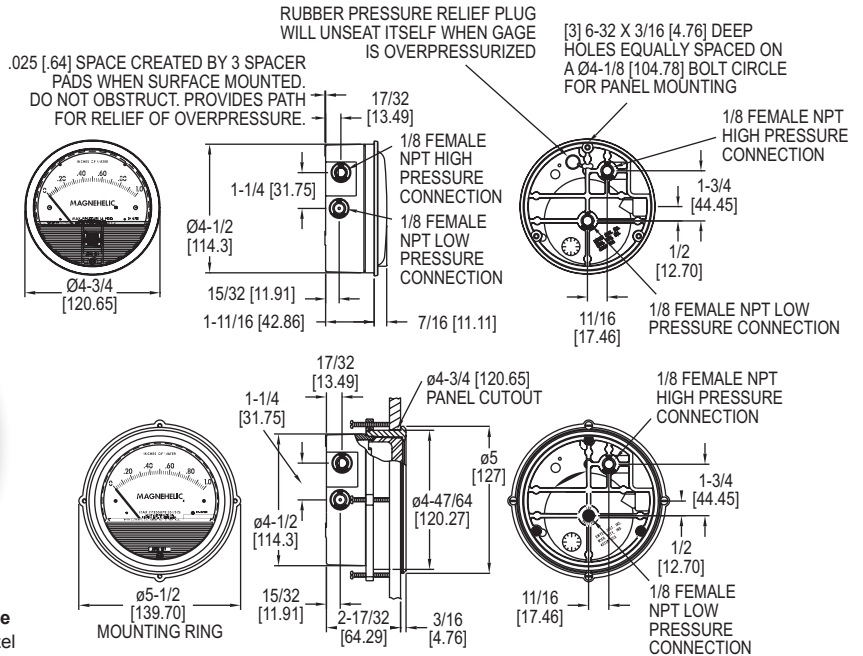

Select the **SERIES 2000** Magnehelic® Gage for a versatile low differential pressure gage with a wide choice of 81 models and 27 options to choose from. Using Dwyer's simple, frictionless Magnehelic® gage movement, it quickly indicates air or non-corrosive gas pressures--either positive, negative (vacuum) or differential. The design resists shock, vibration, over-pressures and is weatherproof to IP67. Select the -HA High Accuracy Magnehelic® gage option for an accuracy within 1% of full scale. Also included with the -HA option at no extra cost are a mirrored scale overlay and a 6 point calibration certificate.

FEATURES/BENEFITS

- Easy to read gage through undistorted plastic face permits viewing from far away
- Patented design provides quick response to pressure changes means no delay in assessing critical situations
- Durable and rugged housing and high-quality components combine to provide long-service life and minimized down-time
- High accuracy option is twice as accurate as the standard Magnehelic® gage

APPLICATIONS

- Filter monitoring
- Air velocity with Dwyer pitot tube
- Blower vacuum monitoring
- Fan pressure indication
- Duct, room or building pressures
- Clean room positive pressure indication

ACCESSORIES

Model	Description
A-432	Portable kit; combine carrying case with any Magnehelic® gage of standard range, except high pressure connection. Includes 9 ft (2.7 m) of 3/16" ID rubber tubing, standhang bracket and terminal tube with holder
A-605	Air filter gage accessory kit; adapts any standard Magnehelic® gage for use as an air filter gage. Includes aluminum surface mounting bracket with screws, two 5 ft (1.5 m) lengths of 1/4" aluminum tubing, two static pressure tips and two molded plastic vent valves, integral compression fittings on both tips and valves
A-605B	Air filter gage accessory kit; air filter kit with two plastic open/close valves, two 4" steel static tips, plastic tubing and mounting flange
A-605C	Air filter gage accessory kit; air filter kit with two plastic open/close valves, two plastic static tips, plastic tubing and mounting flange

SPECIFICATIONS

Service: Air and non-combustible, compatible gases (natural gas option available). **Note:** May be used with hydrogen. Order a Buna-N diaphragm. Pressures must be less than 35 psi.

Wetted Materials: Consult factory.

Housing: Die cast aluminum case and bezel, with acrylic cover. Exterior finish is coated gray to withstand 168 hour salt spray corrosion test.

Accuracy: $\pm 2\%$ (-HA model $\pm 1\%$) of FS ($\pm 3\%$ (-HA $\pm 1.5\%$) on -0, -100PA, -125PA, -10MM and $\pm 4\%$ (-HA $\pm 2\%$) on -00, -60PA, -6MM ranges), throughout range at 70°F (21.1°C).

Pressure Limits: -20 in Hg to 15 psig (-0.677 to 1.034 bar); MP option: 35 psig (2.41 bar); HP option: 80 psig (5.52 bar).

Enclosure Rating: IP67.

Overpressure: Relief plug opens at approximately 25 psig (1.72 bar), standard gages only. **!**

Temperature Limits: 20 to 140°F* (-6.67 to 60°C). -20°F (-28°C) with low temperature option.

Size: 4" (101.6 mm) diameter dial face.

Mounting Orientation: Diaphragm in vertical position. Consult factory for other position orientations.

Process Connections: 1/8" female NPT duplicate high and low pressure taps - one pair side and one pair back.

Weight: 1 lb 2 oz (510 g), MP & HP 2 lb 2 oz (963 g).

Standard Accessories: Two 1/8" NPT plugs for duplicate pressure taps, two 1/8" pipe thread to rubber tubing adapter, and three flush mounting adapters with screws. (Mounting and snap ring retainer substituted for three adapters in MP & HP gage accessories.)

Agency Approvals: Meets the technical requirements of EU Directive 2011/65/EU (RoHS II). **Note:** -SP models not RoHS approved.

Note: For applications with high cycle rate within gage total pressure rating, next higher rating is recommended. See Medium and High pressure options.

*Low temperature models available as special options.



A-432

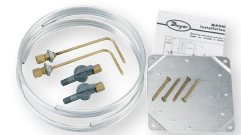

A-605

MAGNEHELIC® DIFFERENTIAL PRESSURE GAGES

Indicate Positive, Negative or Differential, Accurate within 1%

Bezel provides flange for flush mounting in panel.

Clear plastic face is highly resistant to breakage. Provides undistorted viewing of pointer and scale.

Precision litho-printed scale is accurate and easy to read.

Calibrated range spring is flat spring steel. Small amplitude of motion assures consistency and long life. It reacts to pressure on diaphragm. Live length adjustable for calibration.

Red tipped pointer of heat treated aluminum tubing is easy to see. It is rigidly mounted on the helix shaft.

Pointer stops of molded rubber prevent pointer over-travel without damage.

"Wishbone" assembly provides mounting for helix, helix bearings and pointer shaft.

Jeweled bearings are shock-resistant mounted; provide virtually friction-free motion for helix. Motion damped with high viscosity silicone fluid.

Helix is precision made from an alloy of high magnetic permeability. Mounted in jeweled bearings, it turns freely, following the magnetic field to move the pointer across the scale.

Zero adjustment screw is conveniently located in the plastic cover, and is accessible without removing cover. O-ring seal provides pressure tightness.

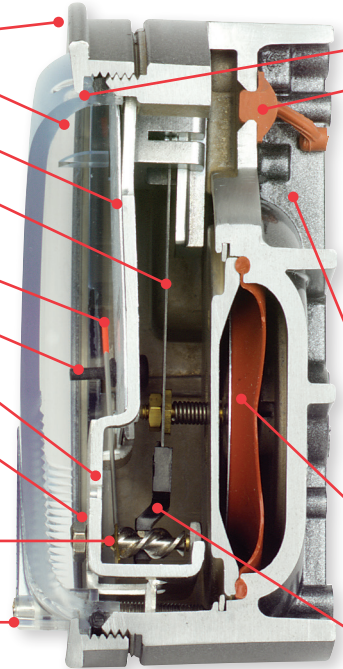

O-ring seal for cover assures pressure integrity of case.

OVERPRESSURE PROTECTION

Blowout plug is comprised of a rubber plug on the rear which functions as a relief valve by unseating and venting the gage interior when over pressure reaches approximately 25 psig (1.7 bar). To provide a free path for pressure relief, there are four spacer pads which maintain 0.023" clearance when gage is surface mounted. Do not obstruct the gap created by these pads.

The blowout plug is not used on models above 180" of water pressure, medium or high pressure models, or on gages which require an elastomer other than silicone for the diaphragm.

The blowout plug should not be used as a system overpressure control. High supply pressures may still cause the gage to fail due to over pressurization, resulting in property damage or serious injury. Good engineering practices should be utilized to prevent your system from exceeding the ratings of any component.

Die cast aluminum case is precision made and iridite-dipped to withstand 168 hour salt spray corrosion test. Exterior finished in baked dark gray hammerloid. One case size is used for all standard pressure options, and for both surface and flush mounting.

Silicone rubber diaphragm with integrally molded O-ring is supported by front and rear plates. It is locked and sealed in position with a sealing plate and retaining ring. Diaphragm motion is restricted to prevent damage due to overpressures.

Samarium Cobalt magnet mounted at one end of range spring rotates helix without mechanical linkages.

MODEL CHART

Model	Range, Inches of Water	Model	Range, PSI	Model	Range, MM of Water	Model	Range, kPa	Dual Scale Air Velocity Units For use with pitot tube	
2000-00N†	0.05-0.2	2201	0-1	2000-6MM†	0-6	2000-0.5KPA	0-0.5	Model	Range, in w.c./ Velocity F.P.M.
2000-00†	0-25	2202	0-2	2000-10MM†	0-10	2000-1KPA	0-1		
2000-0†	0-50	2203	0-3	2000-15MM	0-15	2000-1.5KPA	0-1.5	2000-00AV†	0-25/ 300-2000
2001	0-1.0	2204	0-4	2000-25MM	0-25	2000-2KPA	0-2	2000-0AV†	0-50/ 500-2800
2002	0-2.0	2205	0-5	2000-30MM	0-30	2000-2.5KPA	0-2.5	2001AV	0-1.0/ 500-4000
2003	0-3.0	2210*	0-10	2000-50MM	0-50	2000-3KPA	0-3	2002AV	0-2.0/ 1000-5600
2004	0-4.0	2215*	0-15	2000-80MM	0-80	2000-4KPA	0-4	2005AV	0-5.0/ 2000-8800
2005	0-5.0	2220*	0-20	2000-100MM	0-100	2000-5KPA	0-5	2010AV	0-10/ 2000-12500
2006	0-6.0	2230**	0-30	2000-125MM	0-125	2000-8KPA	0-8		
2008	0-8.0			2000-150MM	0-150	2000-10KPA	0-10		
2010	0-10			2000-200MM	0-200	2000-15KPA	0-15		
2012	0-12	Model	Range, CM of Water	2000-250MM	0-250	2000-20KPA	0-20		
2015	0-15			2000-300MM	0-300	2000-25KPA	0-25		
2020	0-20	2000-15CM	0-15	Zero Center Ranges			2000-30KPA	0-30	
2025	0-25	2000-20CM	0-20	2300-6MM†	3-0-3	Zero Center Ranges			
2030	0-30	2000-25CM	0-25	2300-10MM†	5-0-5	2300-1KPA	0.5-0.5		
2040	0-40	2000-50CM	0-50	2300-20MM†	10-0-10	2300-2KPA	1-0-1		
2050	0-50	2000-80CM	0-80	Model	Range, Pa	2300-2.5KPA	1.25-0-1.25		
2060	0-60	2000-100CM	0-100	2000-100PA	0-100	2300-3KPA	1.5-0-1.5		
2080	0-80	2000-150CM	0-150	2000-60NPA†	10-0-50	Dual Scale English/Metric Models			
2100	0-100	2000-200CM	0-200	2000-60PA†	0-60	Model	Range, in w.c.	Range, Pa or kPa	
2120	0-120	2000-250CM	0-250	2000-100PA†	0-100	2000-00D†	0-25	0-62 Pa	
2150	0-150	2000-300CM	0-300	2000-125PA†	0-125	2000-0D†	0-0.5	0-125 Pa	
2160	0-160	Zero Center Ranges			2000-250PA	0-250	2001D	0-1.0	0-250 Pa
2180*	0-180	2300-4CM	2-0-2	2000-300PA	0-300	2002D	0-2.0	0-500 Pa	
2250*	0-250	2300-10CM	5-0-5	2000-500PA	0-500	2003D	0-3.0	0-750 Pa	
		2300-30CM	15-0-15	2000-750PA	0-750	2004D	0-4.0	0-1.0 kPa	
				2000-1000PA	0-1000	2005D	0-5.0	0-1.25 kPa	
				Zero Center Ranges			2006D	0-6.0	0-1.5 kPa
				Model	Range, Pa	2008D	0-8.0	0-2.0 kPa	
				2300-60PA†	30-0-30	2010D	0-10	0-2.5 kPa	
				2300-100PA†	50-0-50	2015D	0-15	0-3.7 kPa	
				2300-120PA	60-0-60	2020D	0-20	0-5 kPa	
				2300-200PA	100-0-100	2025D	0-25	0-6.2 kPa	
				2300-250PA	125-0-125	2050D	0-50	0-12.4 kPa	
				2300-300PA	150-0-150	2060D	0-60	0-15 kPa	
				2300-500PA	250-0-250				
				2300-1000PA	500-0-500				

†These ranges calibrated for vertical scale position • Accuracy ±3% ** Accuracy ±4% *MP option standard **HP option standard

VELOCITY AND VOLUMETRIC FLOW UNITS

Scales are available on the Magnehelic® gage that read in velocity units (FPM, m/s) or volumetric flow units (SCFM, m³/s, m³/h). Stocked velocity units with dual range scales in inches w.c. and feet per minute are shown above. For other ranges contact the factory. When ordering volumetric flow scales please specify the maximum flow rate and its corresponding pressure. Example: 0.5 in w.c. = 16,000 CFM.

ACCESSORIES

Model	Description
A-321	Safety relief valve
A-448	3-piece magnet kit for mounting Magnehelic® gage directly to magnetic surface
A-135	Rubber gasket for panel mounting
A-401	Plastic carry case
A-310A	3-way vent valves. In applications where pressure is continuous and the Magnehelic® gage is connected by metal or plastic tubing which cannot be easily removed, we suggest using Dwyer A-310A vent valves to connect gage. Pressure can then be removed to check or re-zero the gage.

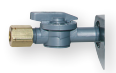

A-310A



HIGH ACCURACY MAGNEHELIC® DIFFERENTIAL PRESSURE GAGE

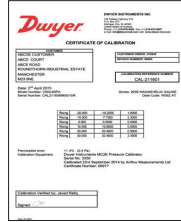
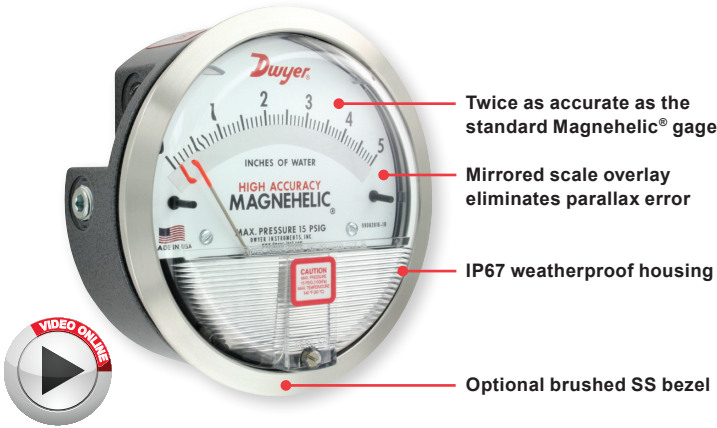

6-Point Calibration Certificate Included

OPTIONS - HIGH ACCURACY MAGNEHELIC® GAGE	
To order add suffix:	Description
-HA	High Accuracy Magnehelic® Gage. Accuracy within 1% and weatherproof. Also includes mirrored scale overlay and a six point calibration certificate
-SS	Corrosion resistant brushed 304 stainless steel bezel

Accuracy Specifications: See page 20 (Series 2000)

ADDITIONAL GAGE OPTIONS

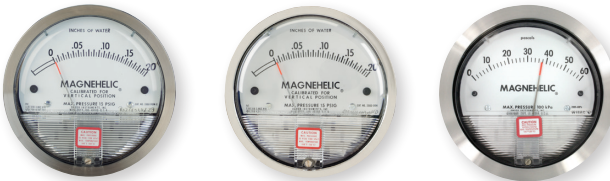

OPTIONS - OTHER OPTIONAL BEZELS	
To order add suffix:	Description
-CB	Chrome bezel option: A chrome plated aluminum bezel for an aesthetically pleasing finish when mounting on metal surfaces such as control panels.
-SB	Stainless steel bezel option: 304 stainless steel electro polished Ra 16 finished bezel.
-SS	Corrosion resistant brushed 304 stainless steel bezel



LED Setpoint Indicator

Adjustable Signal Flag

OPTIONS - LED SETPOINT INDICATOR	
To order add suffix:	Description
-SP	Bright red LED on right scale shows when setpoint is reached. Field adjustable from gage face, unit operates on 12-24 VDC. Setpoint indicator option comes with medium pressure (MP) bezel.

Note: 4-13/16" hole for flush mounting.



Transparent Overlay

Mirrored Scale Overlay

OPTIONS - ADJUSTABLE SIGNAL FLAG	
To order add suffix:	Description
-ASF	Integral with plastic gage cover. Available for most models except those with medium or high pressure construction. Can be ordered with gage or separate.

OPTIONS - TRANSPARENT OVERLAYS	
To order add suffix:	Description
-G	Green (to highlight and emphasize critical pressures)
-R	Red (to highlight and emphasize critical pressures)
-Y	Yellow (to highlight and emphasize critical pressures)

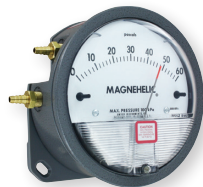

Integrated Mounting Plate

OPTIONS - MIRRORED SCALE OVERLAY	
To order add suffix:	Description
-M	A mirrored scale overlay is also available to assist in reducing parallax error.

OPTIONS - INTEGRATED MOUNTING PLATE	
To order add suffix:	Description
-AHU1	Furnished with attached surface mounting plate
-AHU2	Furnished with attached surface mounting plate and including A-481 installer kit (2 plastic static pressure tips and 7' of PVC tubing)



OPTIONS - FOR HIGH STATE PRESSURE APPLICATIONS	
To order add suffix:	Description
-HP	High pressure option: for pressures to 80 psig
-MP	Medium pressure option: for pressures to 35 psig

OPTIONS	
To order add suffix:	Description
-FC	Factory calibration certificate
-LT	Low temperatures to -20°F (-28°C)
-NIST	NIST traceable calibration certificate

MAGNEHELIC® GAGE MOUNTING ACCESSORIES



A-610



A-369



Pressure Reference Port

A-464

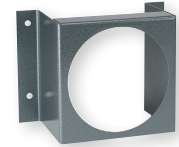

A-299



A-286



A-300



A-368



A-371

A single case size is used for most models of Magnehelic® gages. They can be flush or surface mounted with standard hardware supplied. Complete mounting and connection fittings plus instructions are furnished with each instrument. A 4-9/16" hole is required for flush panel mounting.

Flush mounting is easily accomplished with the new A-300 Flush Mounting bracket. This bracket provides a solution to quickly and conveniently flush mount the Magnehelic® gage. The A-300 is ideal for mounting the Magnehelic® gage on control panel doors.

The A-368 is a simple bracket for quickly surface mounting the Magnehelic® gage. After securing the Magnehelic® gage to the A-368 bracket, mount the bracket on any flat surface.

The A-369 allows the Magnehelic® gage to be easily carried to locations where pressure readings need to be taken. The A-369 can stand on its own or hang on a nail or hook.

ACCESSORIES	
Model	Description
A-610	Pipe mounting kit for installing on 1-1/4" to 2" horizontal or vertical pipe
A-286	Magnehelic® gage panel mounting flange
A-369	Stand-hang bracket, aluminum, for Magnehelic® gage
A-300	Flush mounting bracket
A-464	Flush mount kit for Magnehelic® gage
A-368	Surface mounting plate, aluminum, for Magnehelic® gage
A-299	Mounting bracket, flush mount for Magnehelic® gage, bracket is then surface mounted, steel with gray hammerloid epoxy finish
A-371	Surface mounting bracket, use with medium pressure (-MP) or high pressure (-HP) models only

SERIES A-320

INSTRUMENT ENCLOSURE

Protects Various Instruments



A-320-A



A-320-A With Gage Installed



A-320-B



A-320-B With Gage Installed

SERIES A-320 Instrument Enclosure protects instruments in all applications. The A-320-A fits standard Magnehelic® size instruments (4-9/16" diameter) and the A-320-B fits standard 3000MR Photohelic® switch/gage size instruments (4-13/16" diameter). Both models include silicone tubing, gage barbs and mounting hardware.

MODEL CHART	
Model	Compatible Instruments
A-320-A	2000 Magnehelic® Gage, DM-1000 Digital Differential Pressure Gage, DM-2000 Differential Pressure Transmitter
A-320-B	3000MR Photohelic® Switch/Gage, Series 605 Magnehelic® Differential Pressure Transmitter, DH3 DigiHelic® Pressure Controller, 2000 Magnehelic® Gage with medium and high pressure options

SPECIFICATIONS	
Housing:	ABS.
Process Connections:	Anodized aluminum.
Enclosure Rating:	NEMA 1 (IP10). Note: Check instruments rating.
Weight:	Model A-320-A: 11.29 oz (320 g); A-320-B: 16.23 oz (420 g).
Gage Size Opening:	A-320-A: 4-9/16 in (115.89 mm); A-320-B: 4-13/16 in (122.24 mm).